

Installation Instruction

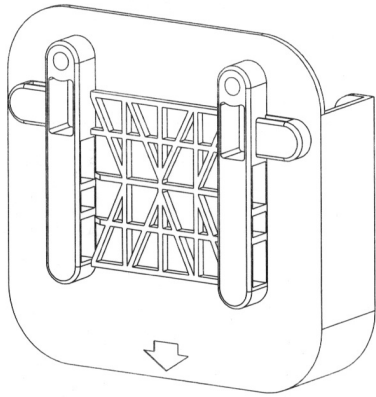

UNPACKING INSTRUCTION

- Carefully open the carton, remove contents and lay out on cardboard or other protective surface to avoid damage.
- Check package contents against the Supplied Parts List in the below to assure that all components were received undamaged. Do not use damaged or defective parts.
- Carefully read all instructions before attempting installation.

Supplied Parts List

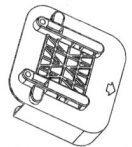

(1)Mount-a



(2)Band-b



(2)Lag Bolt-c

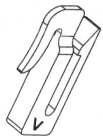

(4)Feet "V"-d



(4)Feed "H"-e

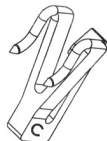

(4)Feet "C"-f

Option A

Attach Mount to the vents on back of TV

Best for people who want a tool-free method that does not damage walls.

Step 1

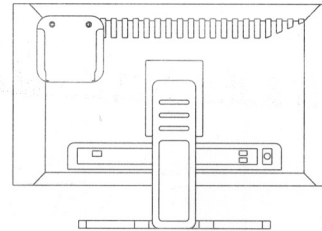

Look at the back of your TV, find the vents near the top of your TV. Determine if the vents are arranged vertical, horizontal or circular.

Step 2

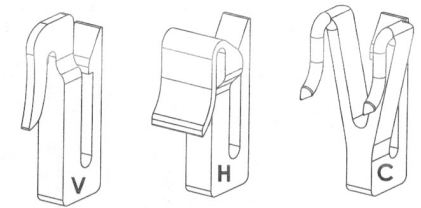

For the TV have the vertical vents, use the hooks labeled "V". For the TV have the horizontal vents, use the hooks labeled "H". For the TV have the circular vents, use the hooks labeled "C".

Step 3

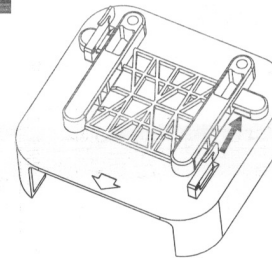

Once you decided the relative hooks, slide one hook into each of the two slots on the back of Mount, as shown in the diagram above.

Step 4

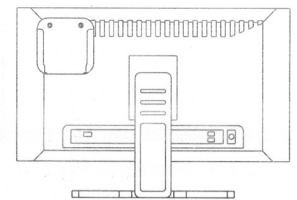

Find the vents within 6 inches of the top of your TV. Connect the Mount to these vents by sliding the hooks into the vents. You may need to wiggle the hooks a little bit to help them go into the vents. If the hooks do not fit, try another hooks from step 2 or try another mounting option.

Step 5

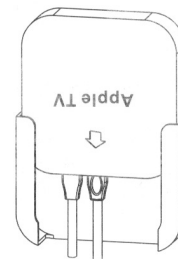

Connect the HDMI and power cables to Apple TV. Slide the Apple TV into the Mount. Make sure the Apple TV cable sockets facing the floor.

Remote Issues of Apple TV

Please try following few methods if your Apple TV does not response your remote control.

1. Face the remote control to the ceiling in various angles to reflect the signal to Apple TV.
2. Make sure the Apple TV cable sockets face to the floor.
3. Make sure the Apple TV was mounted within 6 inches of the top of the TV.
4. Check the battery of your remote control.
5. If nothing else solves the problem, using the "Option C" to mount Apple TV to the wall.

Option B Attach to TV Wall Mount

Use this option if "Option A" does not work and your TV is mounted to a wall.

Step 1

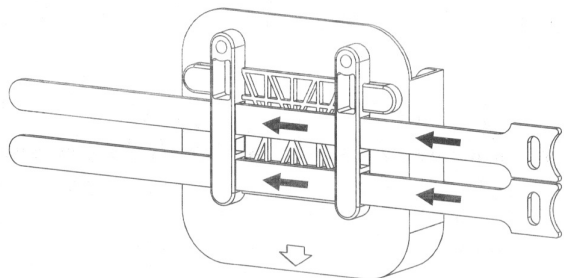

Insert two bands through the holes on the back of Mount as shown right diagram.

Step 2

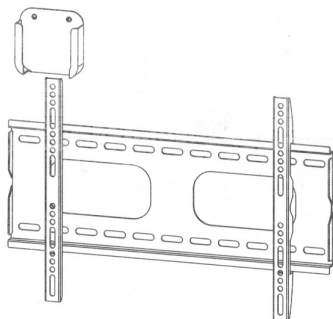

Fasten the bands around the vertical TV mounting bracket. The top of the Mount must be within 6 inches of the top of the TV for remote reception.

Step 3

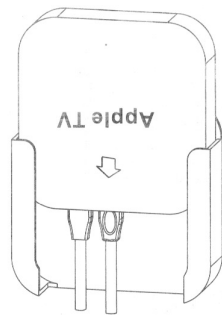

Connect the HDMI and power cables to Apple TV. Slide the Apple TV into the Mount. Make sure the Apple TV cable sockets facing the floor.

Option C Mounting to the Wall

Use this option if none of the other options work. If you have a two-story ceiling. Mount the Apple TV such that at the least one inch of the top of the Apple TV is visible from where you plan to use the remote.

Step 1

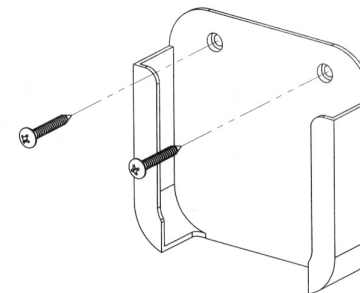

Install the Mount to the wall by two provided Lag Bolts. Please make sure the Apple TV is either not covered by the TV or is within 6 inches of the top of the TV.

Step 2

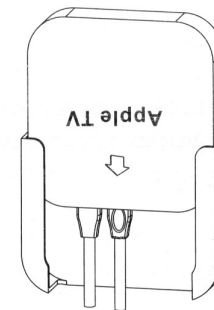

Connect the HDMI and power cables to Apple TV. Slide the Apple TV into the Mount. Make sure the Apple TV cable sockets facing the floor.

Thanks for choosing our product, enjoy the using.